

# Section 13

## Waveguide Adapters & Transformers

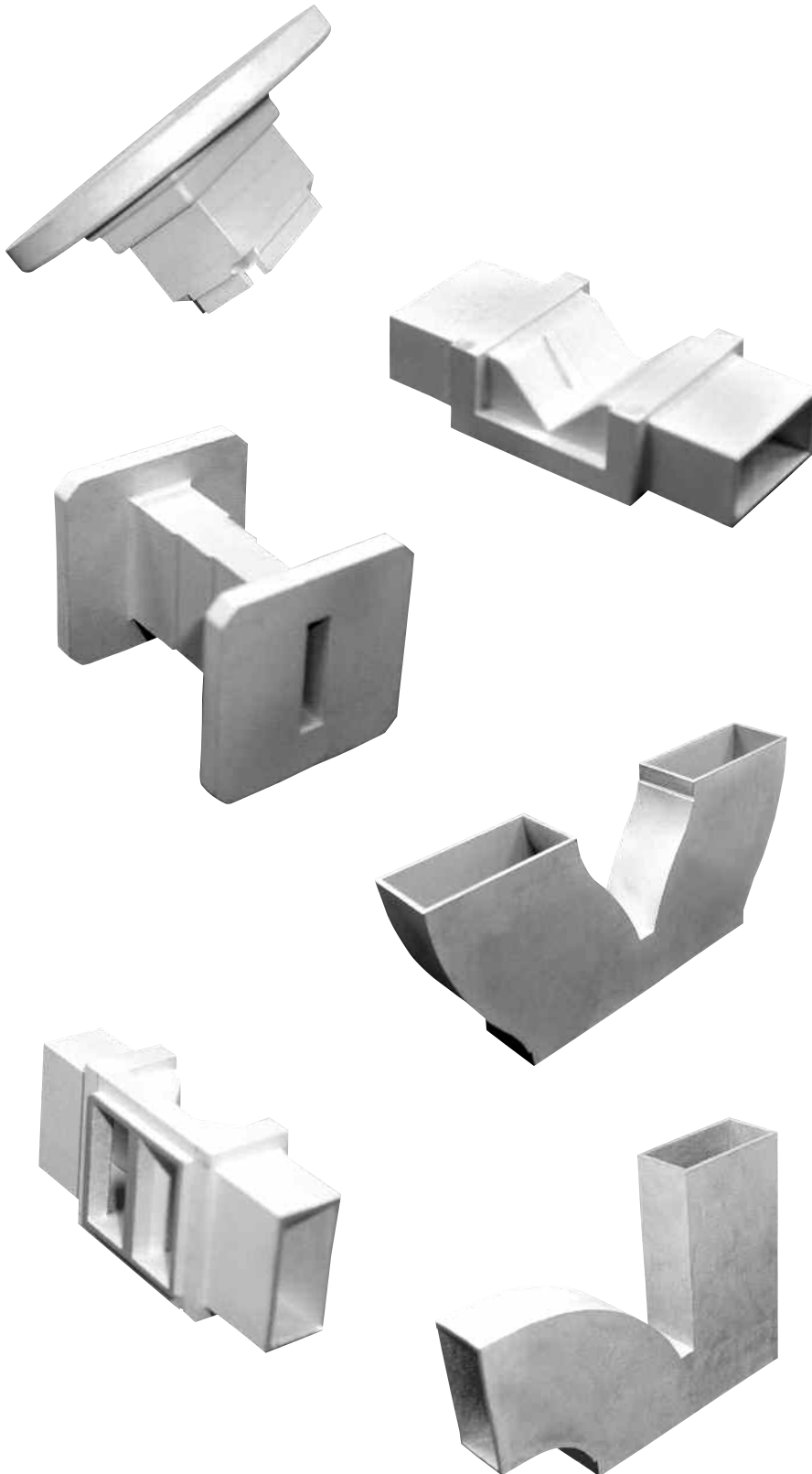

### Introduction

The line of waveguide adapters presented in this catalog represents over 50 years of experience in the mechanical and electrical design of waveguide components. These units are cast within MDL's own foundry facilities. Quality control standards are such as to insure the highest calibre casting. VSWR characteristics of these adapters is typically 1.05.

Units are readily supplied from stock or on short term delivery. In addition to these items, and if customers demands cannot be met with these basic designs, unusual configurations can be fabricated or castings developed to meet specific requirements.

# Sidewall Adapters

## SIDEWALL E AND STRAIGHT ADAPTERS

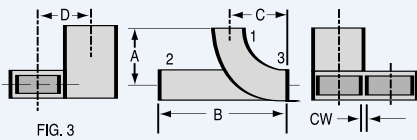
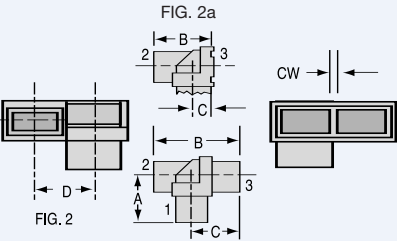
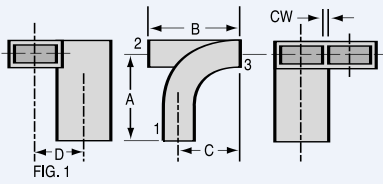

## SIDEWALL H AND STRAIGHT ADAPTERS

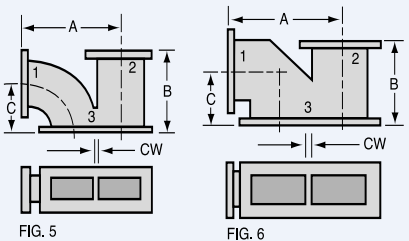
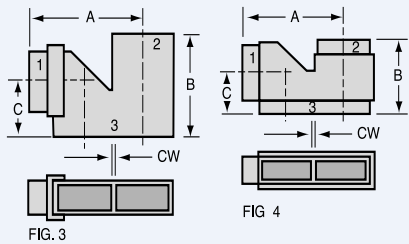
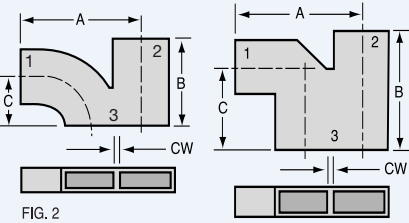

W/G	FIG	C/W	Terminals			MDL Model Number	Dimensions			
			1	2	3		A	B	C	D

### Sidewall E and Straight Adapters

WR62	1	.040	W/G	W/G <sup>1</sup>	W/G <sup>1</sup>	62JS42	1.19	1.22	.81	.66
	1	.040	W/G	W/G <sup>1</sup>	62FS52 <sup>2</sup>	62JS34	1.19	1.22	.81	.66
	3	.040	W/G <sup>3</sup>	W/G	W/G	62JS342	.81	1.56	.62	.66
	1	.090	W/G	W/G <sup>1</sup>	W/G	62JS52	1.19	1.22	.81	.71
	1	.090	W/G	W/G <sup>1</sup>	62FS92 <sup>2</sup>	62JS24	1.19	1.22	.81	.71
	2	.090	W/G	W/G	W/G	62JS212	.59	1.08	.59	.71
	2a	.090	W/G	W/G	Corral	62JS282	.59	.74	.25	.71
WR112	3	.090	W/G <sup>3</sup>	W/G	W/G	62JS292	.81	1.56	.62	.71
	1	.064	W/G <sup>4</sup>	112FA42 <sup>2</sup>	W/G	112JS14	.94	1.20	.50	1.19

- Notes:**
- Terminal #2 will not accept cover flange because of E bend configuration. Add 0.25 to B dimension if choke flange is used.
  - Integrally cast flange: See flange specification table, page 46.
  - Terminal #1 will accept only UG type choke or butt type cover flanges. Add 0.25 to A dimension.
  - Terminal #1 will not accept any flange because of the integrally cast flange on terminal #2.

W/G	FIG	C/W	Terminals			MDL Model Number	Dimensions		
			1	2	3		A	B	C

### Sidewall H and Straight Adapters

WR28	1	.040	W/G	W/G	W/G	28JS32	1.48	1.14	.61
WR42	2	.040	W/G	W/G	W/G	42JS82	1.08	.80	.44
	2	.090	W/G	W/G	W/G	42JS122	1.13	.80	.44
WR62	2	.040	W/G	W/G	W/G	62JS62	1.33	1.21	.58
	2	.040	Corral	W/G	W/G	62JS72	1.33	1.21	.58
	3	.040	W/G	W/G	W/G	62JS302	1.30	1.20	.64
	3	.040	Corral	W/G	W/G	62JS312	1.03	1.20	.64
	3	.090	W/G	W/G	W/G	62JS322	1.35	1.20	.64
	3	.090	Corral	W/G	W/G	62JS332	1.08	1.20	.64
	2	.090	W/G <sup>1</sup>	W/G	W/G	62JS82	1.38	1.21	.58
WR75	2	.050	W/G	W/G	W/G	75JS22	1.60	1.50	.62
WR90	2	.050	W/G <sup>2</sup>	W/G	W/G	90JS42	1.88	1.56	.75
	2	.120	W/G <sup>2</sup>	W/G	W/G	90JS52	2.03	1.56	.75
	4	.120	W/G	W/G	W/G	90JS82 <sup>†</sup>	1.78	1.31	.76
WR112	2	.064	W/G <sup>3</sup>	W/G	W/G	112JS62	2.62	2.13	1.19
	2	.150	W/G <sup>3</sup>	W/G	W/G	112JS72	2.71	2.13	1.19
WR137	2	.074	W/G <sup>4</sup>	W/G <sup>4</sup>	W/G	137JS12	3.36	3.06	1.50
	2	.150	W/G <sup>4</sup>	W/G <sup>4</sup>	W/G	137JS22	3.44	3.06	1.50
B137	6	.150	B137FA12 <sup>5</sup>	B137FA12 <sup>5</sup>	W/G	B137JS14	2.50	1.70	1.26
WR159	5	.150	CMR159 <sup>5</sup>	CMR159 <sup>5</sup>	CMRD-159 <sup>5</sup>	159JS14	3.69	2.93	1.69
WR187	2	.128	W/G <sup>6</sup>	W/G <sup>6</sup>	W/G	187JS22	4.71	4.26	2.18

- Notes:**
- If flange is required use UG type choke or butt-type cover. Add 0.25 to A dimension.
  - If UG choke flange is to be used, add 0.31 to A dimension.
  - If UG choke flange is to be used, add 0.44 to A dimension.
  - If flange is required use UG type choke or butt-type cover. Add 0.50 to A or B dimensions.
  - Integrally cast flange: See flange specification table, page 46.
  - If flange is required use UG type choke or butt-type cover. Add .69 to A or B dimensions.
  - † OD of all terminals are machined to accept ID of flanges.

# Sidewall Adapters

W/G	FIG	C/W	Terminals			MDL Model Number	Dimensions			
			1	2	3		A	B	C	D
<b>Sidewall Panty Adapters</b>										
WR28	1	.040	W/G	W/G	W/G	28JS22	1.12	1.12	.82	.32
	1	.090	W/G	W/G	W/G	28JS42	1.12	1.12	.87	.37
WR42	2	.040	W/G	W/G	W/G	42JS162	.84	.84	.95	.46
	2	.090	W/G	W/G	W/G	42JS72	.84	.84	1.00	.51
WR62	1	.040	W/G	W/G	W/G	62JS12	1.41	1.41	1.52	.66
	1	.090	W/G	W/G	W/G	62JS22	1.41	1.41	1.57	.71
WR75	1	.050	W/G	W/G	W/G	75JS12	1.25	1.25	1.60	.80
C90 (0.900) x0.150HGT	2	.050	W/G <sup>1</sup>	W/G <sup>1</sup>	W/G	C90JS12†	1.43	1.43	2.23	.95
	2	.070	W/G <sup>1</sup>	W/G <sup>1</sup>	W/G	C90JS22†	1.43	1.43	2.25	.97
	2	.100	W/G <sup>1</sup>	W/G <sup>1</sup>	W/G	C90JS32†	1.43	1.43	2.28	1.00
WR90 0.150HGT	1	.050	W/G <sup>2</sup>	W/G <sup>2</sup>	W/G	90JS62	1.13	1.13	1.69	.95
	2	.050	W/G <sup>2</sup>	W/G <sup>2</sup>	W/G	90JS92	1.22	1.22	1.90	.95
	1	.120	W/G <sup>2</sup>	W/G <sup>2</sup>	W/G	90JS32	1.13	1.13	1.76	1.02
WR112	1	.064	W/G <sup>3</sup>	W/G <sup>3</sup>	W/G	112JS32	1.28	1.28	1.94	1.19
	1	.150	W/G <sup>3</sup>	W/G <sup>3</sup>	W/G	112JS42	1.28	1.28	2.03	1.27
WR187	1	.128	W/G <sup>4</sup>	W/G <sup>4</sup>	W/G	187JS12	2.69	2.69	3.88	2.00

- Notes:** <sup>1</sup> If flange is required use C90FA12 (see flange specification table on page 46) OD of terminals machined to accept ID of flange.  
<sup>2</sup> If UG choke flange is to be used add 0.31 to A or B dimensions.  
<sup>3</sup> If flange is required use UG type choke or butt type cover. Add 0.44 to A or B dimensions.  
<sup>4</sup> If flange is required use UG type choke or butt type cover. Add 0.69 to A or B dimensions for choke flanges. 0.38 for cover flange.  
† OD of terminals 1 and 2 are machined to accept ID of flanges.

W/G	FIG	C/W	Terminals			MDL Model Number	Dimensions				
			1	2	3		A	B	C	D	
<b>Sidewall Dual H</b>											
WR28	1	.040	W/G	W/G	W/G	28JS12	1.16	.69	2.17	.61	
WR42	2	.040	W/G	W/G	W/G	42JS12	.62	.62	1.70	.44	
	2a	.040	Corral	Corral	W/G	42JS32	.73	.73	1.92	.44	
	2	.090	W/G	W/G	W/G	42JS42	.62	.62	1.75	.44	
	2a	.090	Corral	Corral	W/G	42JS52	.73	.73	1.97	.44	
WR62	2	.040	W/G	W/G	W/G	62JS92	1.29	1.29	3.24	.88	
	2a	.040	Corral	Corral	W/G	62JS112	1.38	1.38	3.42	.88	
	3	.040	W/G	W/G	W/G	62JS232	.75	.75	2.16	.64	
	3a	.040	Corral	Corral	W/G	62JS262	.37	.37	1.40	.64	
	2	.090	W/G	W/G	W/G	62JS122	1.29	1.29	3.29	.88	
	2a	.090	Corral	Corral	W/G	62JS142	1.38	1.38	3.47	.88	
	3	.090	W/G	W/G	W/G	62JS222	.75	.75	2.21	.64	
	3a	.090	Corral	Corral	W/G	62JS272	.37	.37	1.45	.64	
	WR90 .200HGT	7	.050	Corral	Corral	W/G	A90JS32	.575	.575	2.100	.690
		8	.050	W/G	W/G	Corral	A90JS42	.775	.775	2.500	.575
9		.050	Corral	Corral	Corral	A90JS52	.575	.575	2.100	.575	
WR90	1	.050	W/G	W/G	W/G	90JS12	.98	.98	2.91	.79	
	1	.120	W/G	W/G	W/G	90JS22	.98	.98	2.98	.79	
WR112	1	.064	W/G	W/G	W/G	112JS12	1.10	1.10	3.39	.97	
	1	.150	W/G	W/G	W/G	112JS22	1.10	1.10	3.47	.97	

W/G	FIG	C/W	Terminals			MDL Model Number	Dimensions				
			1	2	3		A	B	C	D	E
<b>Sidewall E &amp; H Adapter</b>											
WR90	6	.050	W/G	W/G	Corral	90JS72†	1.84	2.62	.75	.75	.95

- Notes:** <sup>1</sup> Integrally cast flange: See flange specification table, page 46.  
<sup>2</sup> If flange is required use UG type choke or butt type cover. Add .312 to B dimension.  
† OD of terminals 1 and 2 are machined to accept ID of flanges.

## SIDEWALL PANTY ADAPTERS

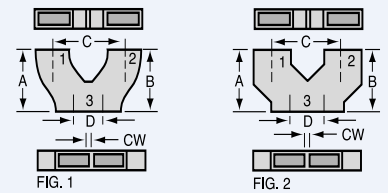

## SIDEWALL DUAL H

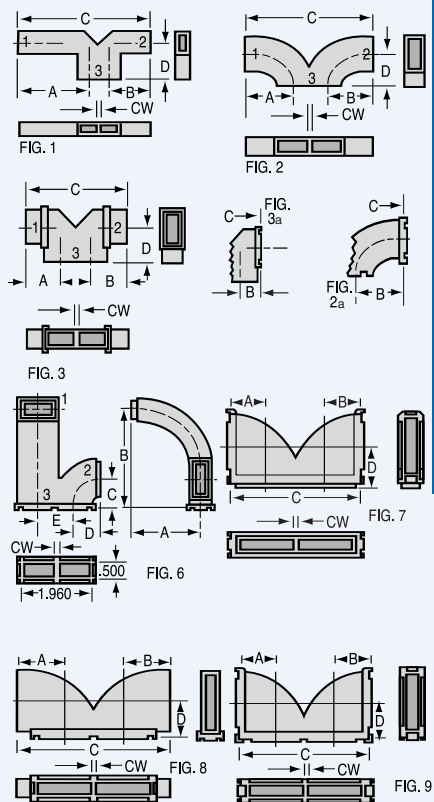

# Topwall Adapters

## TOPWALL DUAL E ADAPTERS

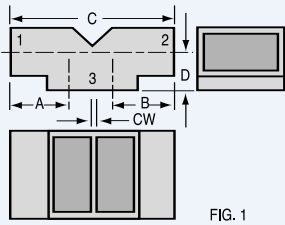

FIG. 1

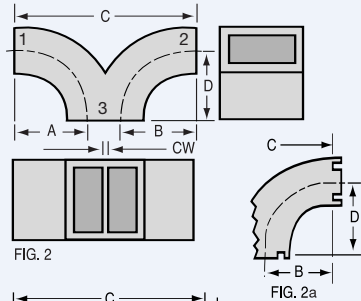

FIG. 2

FIG. 2a

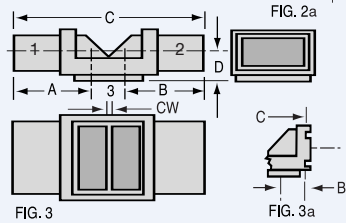

FIG. 3

FIG. 3a

## TOPWALL E AND STRAIGHT ADAPTERS

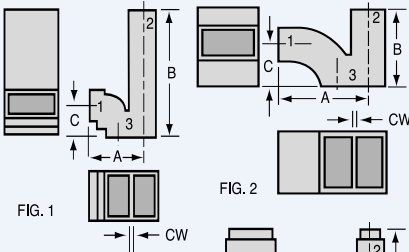

FIG. 1

FIG. 2

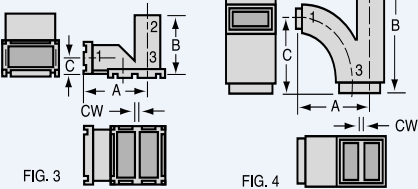

FIG. 3

FIG. 4

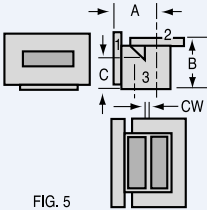

FIG. 5

## TOPWALL H AND STRAIGHT ADAPTER

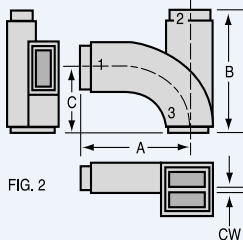

FIG. 2

CW

W/G	FIG	C/W	Terminals			MDL Model Number	Dimensions			
			1	2	3		A	B	C	D

### Topwall Dual E Adapters

WR51	1	.040	W/G <sup>1</sup>	W/G <sup>1</sup>	W/G	51JT32	.42	.42	1.14	.25
WR62	2	.090	W/G <sup>1</sup>	W/G <sup>1</sup>	W/G	62JT12	.69	.69	1.78	.50
WR90	2	.050	W/G <sup>2</sup>	W/G <sup>2</sup>	W/G	90JT22	.99	.99	2.43	.75
	2a	.050	Corral	Corral	Corral	90JT112	.90	.90	2.25	.90
	3	.050	W/G	W/G	W/G	90JT62	1.03	1.03	2.50	.39
	3a	.050	Corral	Corral	W/G	90JT52	.33	.33	1.10	.39
	2	.120	W/G <sup>2</sup>	W/G <sup>2</sup>	W/G	90JT12	.99	.99	2.50	.75
WR112	2a	.120	Corral	Corral	Corral	90JT122	.90	.90	2.32	.90
	3	.120	W/G	W/G	W/G	90JT72	1.03	1.03	2.57	.39
	3a	.120	Corral	Corral	W/G	90JT82	.33	.33	1.17	.39
	3	.064	W/G <sup>3</sup>	W/G <sup>3</sup>	W/G	112JT32	.86	.86	2.28	.45
	3a	.064	Corral	Corral	W/G	112JT42	.34	.34	1.25	.45
	3	.150	W/G <sup>3</sup>	W/G <sup>3</sup>	W/G	112JT12	.86	.86	2.37	.45
	3a	.150	Corral	Corral	W/G	112JT22	.34	.34	1.34	.45

Notes: <sup>1</sup> If flange is required use UG type choke or butt-type cover. Add .250 to A or B dimensions.

<sup>2</sup> If flange is required use UG type choke or butt-type cover. Add .312 to A or B dimensions.

<sup>3</sup> If UG choke is required add .44 to A or B dimensions.

W/G	FIG	C/W	Terminals			MDL Model Number	Dimensions		
			1	2	3		A	B	C

### Topwall E and Straight Adapters

WR51	1	.040	W/G <sup>1</sup>	W/G	W/G	51JT12	.66	1.48	.36
WR62	2	.090	W/G <sup>1</sup>	W/G	W/G	62JT22	1.09	.90	.50
WR90	3	.050	Corral	W/G	Corral	90JT92	1.50	1.14	.32
	3	.050	90FA92 <sup>2</sup>	90FA92 <sup>2</sup>	Corral	90JT14	1.53	1.12	.32
	4	.120	W/G <sup>3</sup>	W/G	W/G	90JT32†	1.72	3.16	1.74
	3	.120	Corral	W/G	Corral	90JT102	1.57	1.14	.32
	3	.120	90FA92 <sup>2</sup>	90FA92 <sup>2</sup>	Corral	90JT24	1.60	1.12	.32
B137	5	.150	B137FA12 <sup>2</sup>	B137FA12 <sup>2</sup>	W/G	B137JT14	1.17	1.36	.82

(1.372x0.487 ID)

Notes: <sup>1</sup> If flange is required use UG type choke or butt-type cover. Add .250 to A dimension.

<sup>2</sup> Flange integrally cast. See flange specification table, page 46.

<sup>3</sup> If flange is required use UG type choke or butt-type cover. Add .312 to A dimension.

† OD of all terminals are machined to accept ID of flanges.

W/G	FIG	C/W	Terminals			MDL Model Number	Dimensions		
			1	2	3		A	B	C

### Topwall H and Straight Adapter

WR90	2	.120	W/G	W/G	W/G	90JT42†	2.54	2.84	1.48
------	---	------	-----	-----	-----	---------	------	------	------

Notes: † OD of all terminals are machined to accept ID of flanges.

# Single Waveguide to Waveguide Adapters

W/G	A	B (TYP)	C	D	E	F (REF)	G	H	MDL Model Number
WR28	0.125	0.06	0.280	0.140	0.361	0.500	0.221	0.375	28JA12
WR42	0.187	0.09	0.420	0.170	0.502	0.625	0.252	0.375	42JA12
WR62	0.187	0.50	0.622	0.311	0.704	0.812	0.393	0.500	62JA12
	0.093	0.50	0.622	0.311	0.704	0.812	0.393	0.500	62JA32
WR75	0.094	0.09	0.750	0.375	0.814	0.910	0.439	0.540	75JA12
	0.094	0.09	0.750	0.375	0.852	0.910	0.477	0.535	75JA22
WR90	0.094	0.09	0.900	0.400	1.004	1.100	0.505	0.600	90JA12
WR90	0.094	0.09	0.900	0.200	1.002	1.100	0.302	0.400	A90JA12
WR102	0.094	0.08	1.020	0.510	1.150	1.220	0.640	0.710	102JA12
WR112	0.250	0.08	1.122	0.497	1.252	1.312	0.627	0.687	112JA12
WR137	0.250	0.09	1.372	0.622	1.503	1.625	0.753	0.875	137JA12
B137	0.125	0.14	1.372	0.487	1.504	1.625	0.619	0.750	B137JA12
(1.372x0.487 ID)									
WR187	0.312	0.12	1.872	0.872	2.004	2.062	1.004	1.062	187JA12
WR229	0.312	0.12	2.290	1.145	2.423	2.550	1.278	1.400	229JA12
WR284	0.312	0.14	2.840	1.340	3.006	3.240	1.506	1.740	284JA12
B284	0.125	0.14	2.840	1.004	3.006	3.170	1.170	1.330	B284JA12
(2.840x1.004 ID)									

SINGLE WAVEGUIDE TO WAVEGUIDE ADAPTERS

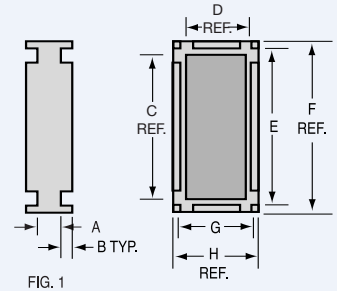

# Transformers Waveguide

Waveguide transformers provide the means of propagating RF energy from one waveguide size to another. This transmission may be achieved by smooth tapers or stepped configurations. Reflections encountered within these transformers are kept to a minimum over the frequency range common to both waveguide sizes.

Methods of manufacture include casting, fabrication, and electroforming, depending on the material required and the waveguide sizes.

Electrical Data				Mechanical Data		
W/G Size	Frequency (GHz)	Model Number	VSWR	Length <sup>3</sup>	Terminations* Flange Face = JAN or Equivalent W/G = EIA or Equivalent	
					Small End	Large End

## Waveguide

WR22-WR28	33.0-40.0	22EU14-1*	1.06	1.75	UG-383/U	UG-599/U
WR28-WR42 <sup>1</sup>	25.0-28.0	28EU16-1*	1.08	2.00	UG-599/U	UG-595/U
WR34-.340sq.	19.0-31.0	SQ34EU16-1*	1.10	1.50	UG-1530/U	UG-1530/U
WR42-WR62	16.5-19.0	42EU14-1*	1.05	1.50	UG-595/U	UG-419/U
WR42-WR51	17.0-23.0	42EU16-1*	1.06	1.50	UG-595/U FOUR .144 DIA. HOLES	1.32x1.32
WR51-WR62	13.5-19.0	51EU16-1*	1.07	0.87	COVER FLANGE 1.32x1.32 FOUR .144 DIA. HOLES	UG-419/U
	14.0-19.0	51EU26-1*	1.05	2.15	COVER FLANGE 1.32x1.32 FOUR .144 DIA. HOLES	UG-419/U
WR62-WR75	11.0-15.0	62EU14-1*	1.07	2.00	UG-419/U	FLG. FACE EQUIV. MIL-F-3922/70-016/017
WR62-WR90 <sup>1</sup>	11.5-13.1	62EU16-1*	1.05	3.11	UG-419/U	UG-39/U
WR62-622 dia.	12.8-18.0	Ci62EU16	1.10	2.75	.622x311 I.D. OPENING CIRCULAR OUTPUT	.622 DIA. I.D.
WRD750-WR62	12.4-18.0	D750EU16-1*	1.10	7.00	UG-419/U COVER FLANGE	WRD750-D24
WRD750-WR90	8.2-12.4	D750EU26-1*	1.10	7.00	WRD750-D24 COVER FLANGE	UG-39/U
WR75-WR90	9.9-12.5	75EU26-1*	1.06	1.21	1.50x1.50 FOUR .144 DIA. HOLES	UG-39/U
WR90-WR102	7.6-11.0	90EU14-1*	1.05	1.25	UG-39/U	UG-1493/U
WR90-WR112	7.5-10.5	90EU15	1.12	1.00	WR90 CORRAL	UG-51/U
	7.5-10.5	90EU36-1*	1.10	1.42	UG-39/U	UG-51/U
WR90-(.900x.200)	8.2-12.4	A90EU16-1*	1.05	2.00	UG-39/U	UG-39/U
WR90-(.900x.200)	8.2-12.4	A90EU36	1.05	0.75	WR90 (.900x.200) CORRAL	WR90 CORRAL
WR90-(.900x.200)	8.5-9.6	A90EU46	1.05	0.50	WR90 (.900x.200) CORRAL	WR90 CORRAL
WR90-(.900x.150)	8.4-9.6	C90EU16-1*	1.05	2.00	UG-39/U	UG-39/U
WR90-.800 sq.	8.2-12.4	SQ90EU16-1*	1.10	1.86	UG-39/U	1.60 DIA. O.D.
					CIRCULAR FRAME	
WR102-WR112	7.0-10.0	102EU14-1*	1.05	1.50	UG-1493/U	UG-51/U
WR112-WR137 <sup>1</sup>	7.0-8.2	112EU16-1*	1.05	6.19	UG-51/U	UG-344/U
WR137-WR159 <sup>1</sup>	5.5-7.0	137EU16-1*	1.05	7.00	UG-344/U	CPR-159/F
WR137-WR187	5.0-6.3	137EU36-1*	1.07	1.91	UG-344/U	UG-149/U
WR137-WR187	5.0-6.3	137EU46	1.07	1.36	WR137 CORRAL	UG-149/U
WR187-WR229	3.7-4.6	187EU16-1*	1.08	1.51	UG-149A/U	CPR-229F
WR284-WR340 <sup>2</sup>	2.6-3.3	284EU14-1*	1.05	3.03	UG-584/U	UG-554/U LESS GROOVES

Notes: M = Mandrel. F = Fabricated. SC = Sand Casting. S = Smooth Taper. X ( ) = Step Transformer (No. of Steps)

\* Cover Flanges

<sup>1</sup> Supplied in copper alloy only

<sup>2</sup> Supplied in aluminum alloy only

<sup>3</sup> Dimensions shown are for cover flanges, both ends.

When using choke flanges extra length may be added.

Check with the factory for proper dimensions.

Aluminum flanges when required will be equivalent to the brass flanges shown.

All flanges tabulated are brass except where noted.

